

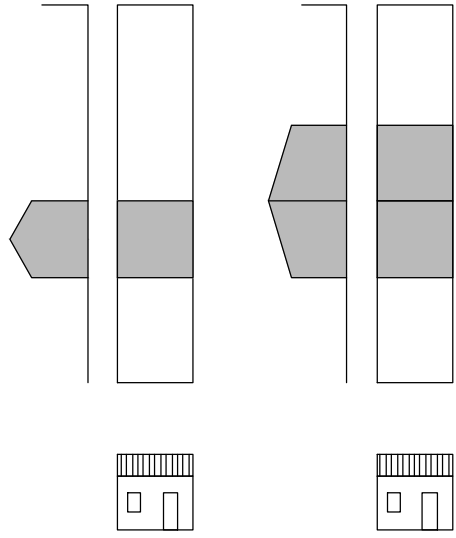

Aa-1 Bicellula in profondità su un livello



SCHEMA BASE

Aa-4 Bicellula in larghezza su un livello, con loggiato

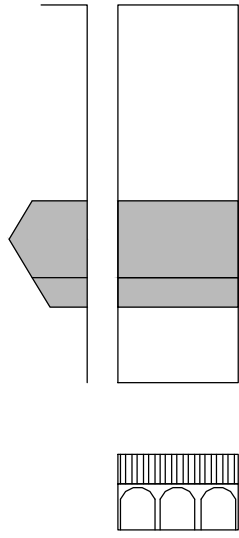

Aa-5 Bicellula in larghezza su due livelli

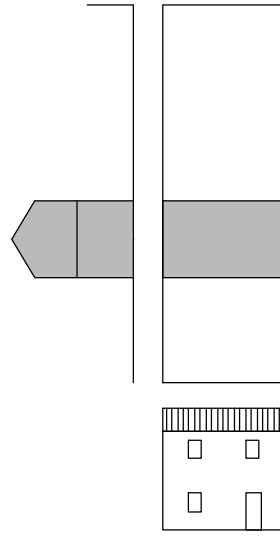

Aa-6 Bicellula in larghezza su due livelli, con loggiato

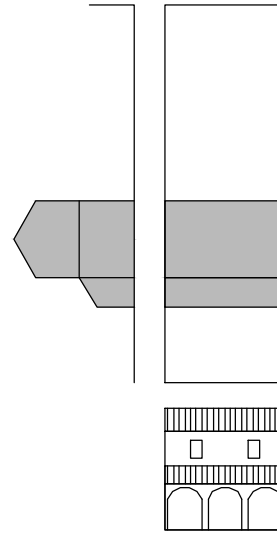

Aa-8 Bicellula in larghezza e in profondità su due livelli

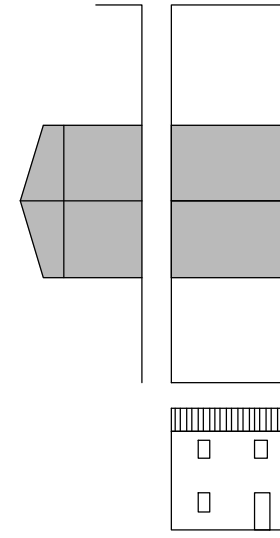

Aa-9 Bicellula in larghezza su due livelli, con loggiato e aggiunte laterali

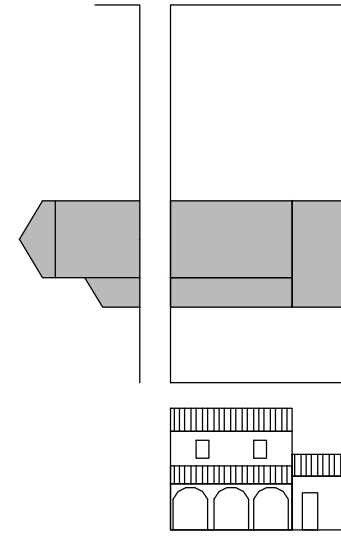

Ab-1 Tre o più cellule in larghezza su un livello, con loggiato

**Bicellula in**

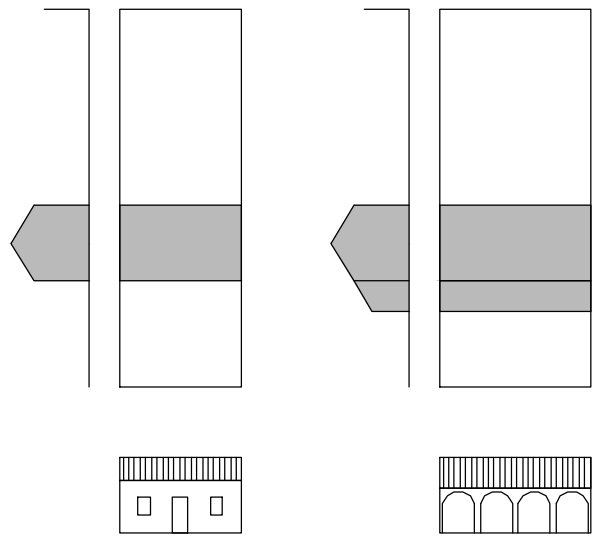

SCHEMA BASE

Ab-2 Tre cellule in larghezza su due livelli

**SVILUPPO IN**

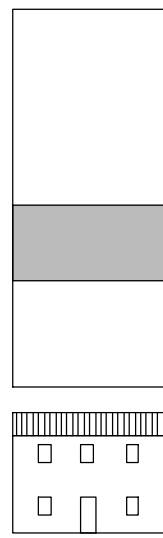

SVILUPPO IN LARGHEZZA

Ab-3 Tre cellule in larghezza su due livelli, con aggiunta sul retro e loggiato

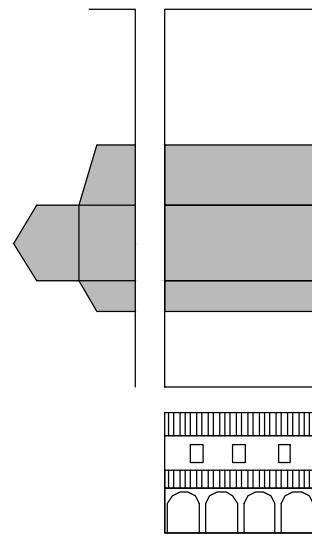

# ABACO TIPOLOGICO

Abaco delle tipologie edilizie presenti nel Centro Matrice

## Impianti planimetrici di base a due cellule

Ba impianti planimetrici di base a due cellule

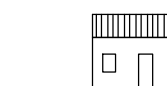
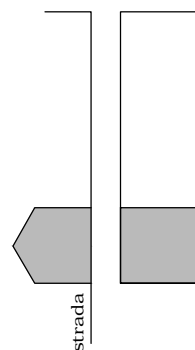

SCHEMA BASE

Ba-1 Bicellula in profondità su un livello

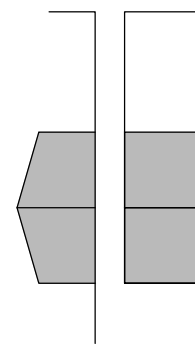

SVILUPPO IN PROFONDITA'

## Impianti planimetrici di base a tre o più cellule

Bb Impianti planimetrici di base a tre o più cellule

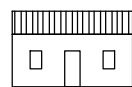
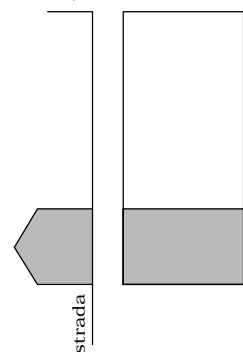

SCHEMA BASE

Bb-1 Tre cellule in larghezza e in profondità su un livello, con "sala"

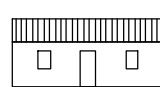
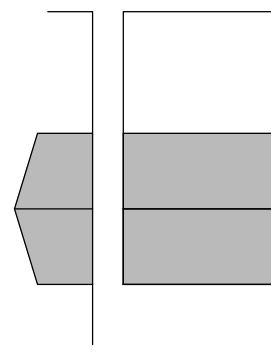

SVILUPPO IN LARGHEZZA

Bb-2 Tre cellule in larghezza su due livelli

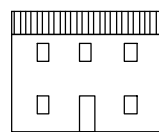
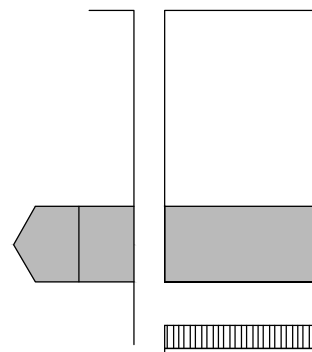

SVILUPPO IN LARGHEZZA E IN ALTEZZA

Bb-3 Tre cellule in larghezza su due livelli, con passo carraio laterale

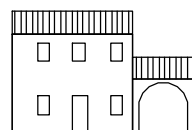
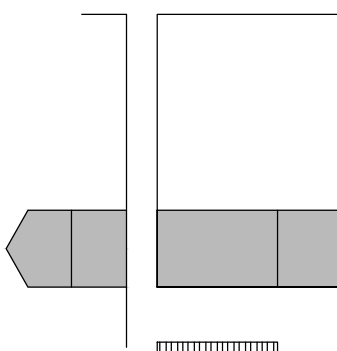

SVILUPPO IN LARGHEZZA E IN ALTEZZA

Bb-4 Tre cellule in larghezza su due livelli, con passo carraio inglobato

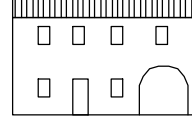
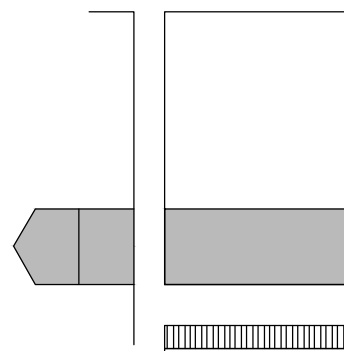

SVILUPPO IN LARGHEZZA E IN ALTEZZA

Bb-7 Palazzetto con tre cellule in larghezza su due livelli, con passo carraio inglobato

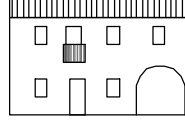
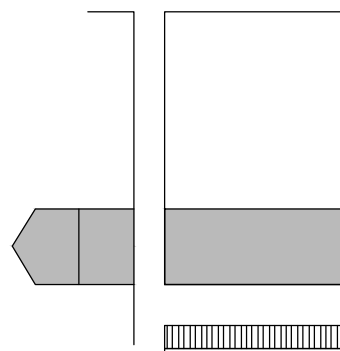

SVILUPPO IN LARGHEZZA E IN ALTEZZA

## Sviluppo delle abitazioni di base a una o due cellule

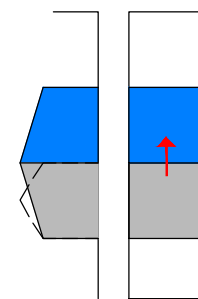

SVILUPPO IN PROFONDITÀ

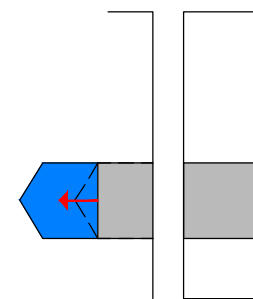

SVILUPPO IN ALTEZZA

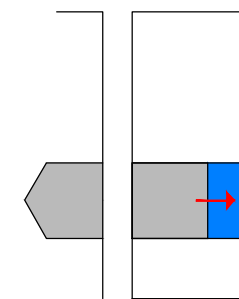

SVILUPPO IN LARGHEZZA

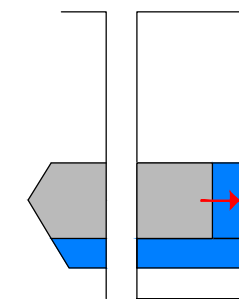

SVILUPPO IN LARGHEZZA E LOGGIATO

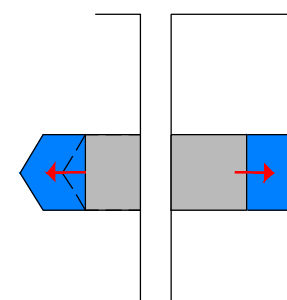

SVILUPPO IN LARGHEZZA E IN ALTEZZA

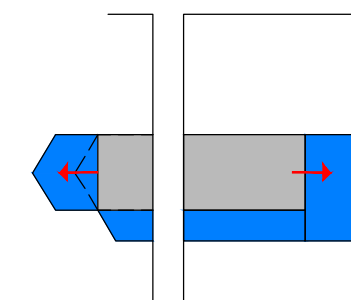

SVILUPPO IN ALTEZZA, LARGHEZZA E PROFONDITÀ

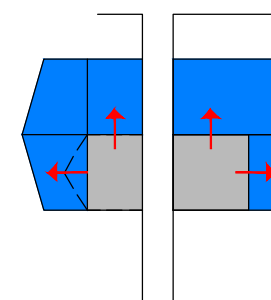

SVILUPPO IN LARGHEZZA E PROFONDITÀ

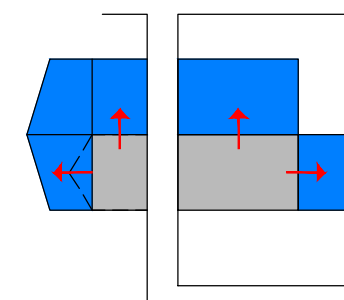

SVILUPPO IN ALTEZZA, LARGHEZZA E PROFONDITÀ

## Sviluppo delle abitazioni a tre o più cellule

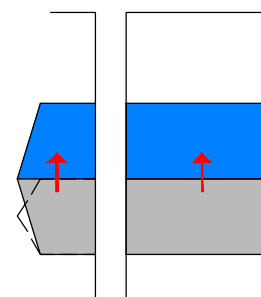

SVILUPPO IN PROFONDITÀ

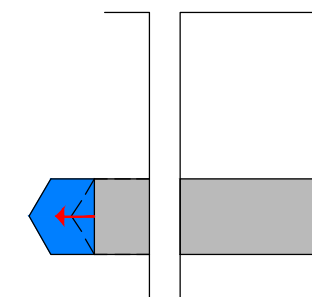

SVILUPPO IN ALTEZZA

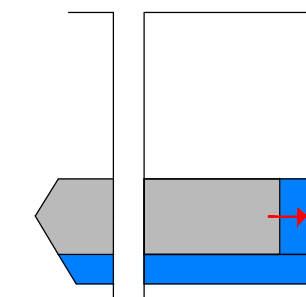

SVILUPPO IN LARGHEZZA E LOGGIATO

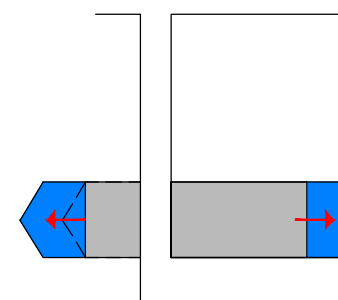

SVILUPPO IN LARGHEZZA E IN ALTEZZA

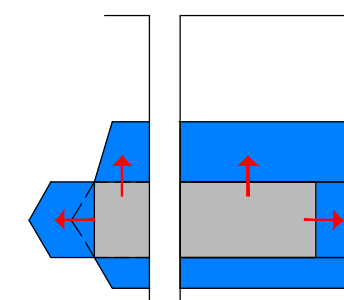

SVILUPPO IN LARGHEZZA, IN PROFONDITÀ E IN ALTEZZA